

FITTINGS

ROHRFORMSTÜCKE



02 PIPE UNIONS
 ROHRVERBINDUNGEN



03 FITTINGS
 ROHRFORMSTÜCKE

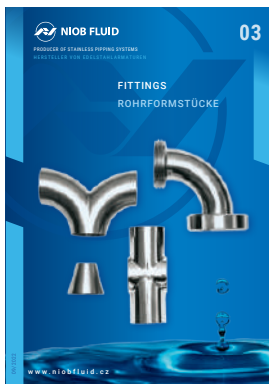

04 VALVES AND COCKS
 VENTILE UND HÄHNNE



05 SPECIAL FITTINGS AND PARTS
 SPEZIALARMATUREN UND TEILE



06 DOORS AND MANWAYS
 MANNLOCHTÜREN UND KLAPPTÜREN



07 ACCESSORIES
 ZUBEHÖR



08 DOUBLE-WALLED PIPING SYSTEMS
 DOPPELWANDIGE ROHRSYSTEME



09 ASEPTIC PROGRAM
 ASEPTISCHES PROGRAMM



The company NIOB FLUID s. r. o. is a manufacturer focused on the production of fasteners, shut-off and control valves of stainless steels. These valves are especially designed for the transport of liquids in the food, chemical and the pharmaceutical industry. It is simultaneously also the supplier of pipe fittings and other parts needed for piping systems and components for tanks such as the lid, manwaydoor, level indicator and other components.

Die Gesellschaft NIOB FLUID s.r.o. ist ein Hersteller, der auf die Produktion von Verbindungs-, Absperr- und Regulierungsarmaturen aus Edelstahl orientiert ist. Diese Armaturen sind vor allem für den Transport von Flüssigkeiten in der Lebensmittel- und Chemieindustrie und in der Pharmazie bestimmt. Die Gesellschaft ist gleichzeitig auch Lieferant von Rohrverbindungsstücken und weiteren Teilen, die für die Rohrleitungen erforderlich sind, und von Behälterteilen wie Hauben, Luken, Standgläser und weitere Komponenten.

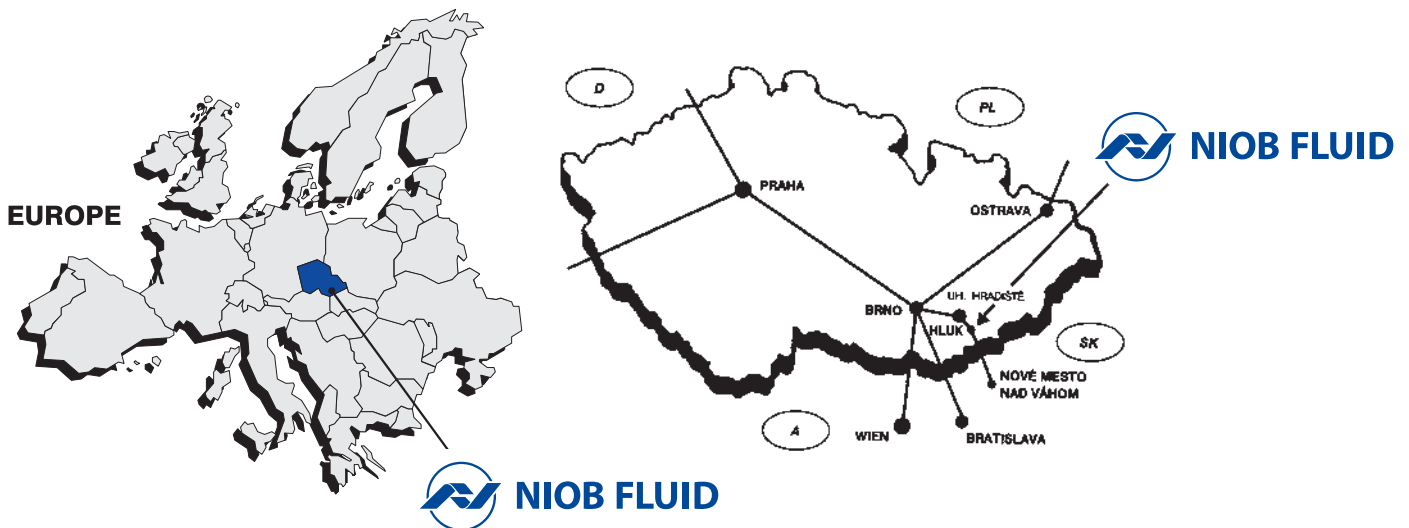

NIOB FLUID s. r. o.
Ostrožská 1003, 687 25 Hluk, Czech Republic
Phone: +420 572 419 822 – 8, Fax: +420 572 419 868
E-mail: marketing@niobfluid.cz, www.niobfluid.cz

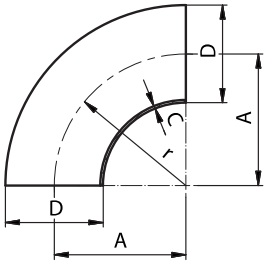
Bend 90° S - S Bogen 90° S - S	30010	Dimensions • Baumaße									
		DN	D	A	C	r					kg
		10	12	26	1,5	26					0,02
		10	13	26	1,5	26					0,02
		15	18	35	1,5	35					0,04
		15	19	35	1,5	35					0,04
		20	22	40	1,5	40					0,04
		20	23	40	1,5	40					0,08
		25	28	50	1,5	50					0,08
		25	29	50	1,5	50					0,08
		32	34	55	1,5	55					0,10
		32	35	55	1,5	55					0,10
		40	40	60	1,5	60					0,20
		40	41	60	1,5	60					0,20
		50	52	70	1,5	70					0,20
		50	53	70	1,5	70					0,20
		65	70	80	2,0	80					0,40
		80	85	90	2,0	90					0,56
		100	104	100	2,0	100					0,76
		125	129	187,5	2,0	187,5					1,64
		150	154	225	2,0	225					2,60

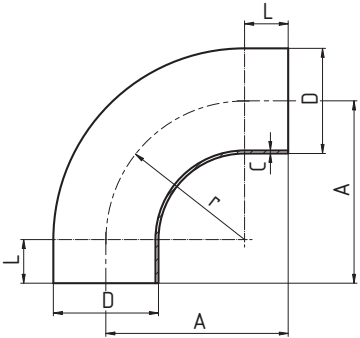
Bend 90° S - S Bogen 90° S - S	30021 DIN 11852	Dimensions • Baumaße						
		DN	D	A	L	C	r	
		10	12	51	25	1,5	26	
		15	18	60	25	1,5	35	
		20	22	52	12	1,5	40	
		25	28	65	15	1,5	50	
		32	34	73	18	1,5	55	
		40	40	80	20	1,5	60	
		50	52	92	22	1,5	70	
		65	70	105	25	2	80	
		80	85	119	29	2	90	
		100	104	140	40	2	100	
		125	129	251	63,5	2	187,5	
		150	154	288,5	63,5	2	225	

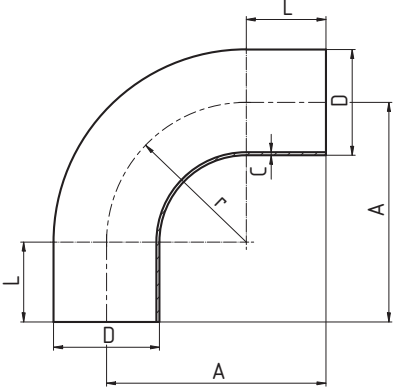
Bend 90° S - S Bogen 90° S - S	30022 DIN 11865	Dimensions • Baumaße						
		DN	D	A	L	C	r	
		10	13	51	25	1,5	26	
		15	19	60	25	1,5	35	
		20	23	65	25	1,5	40	
		25	29	90	40	1,5	50	
		32	35	95	40	1,5	55	
		40	41	100	40	1,5	60	
		50	53	110	40	1,5	70	
		65	70	120	40	2	80	
		80	85	145	55	2	90	
		100	104	155	55	2	100	
		125	129	270	82,5	2	187,5	
		150	154	325	100	2	225	

Bend 90° G - S Bogen 90° G - S	30040	Dimensions • Baumaße										
		DN	A	B	C	D	E	F	R	L	Rd x s	kg
	10	26	10	1,5	13	43					28x1/8	0,06
	15	35	16	1,5	19	52					34x1/8	0,08
	20	40	20	1,5	23	59					44x1/6	0,12
	25	50	26	1,5	29	72					52x1/6	0,18
	32	55	32	1,5	35	77					58x1/6	0,22
	40	60	38	1,5	41	82					65x1/6	0,36
	50	70	50	1,5	53	93					78x1/6	0,42
	65	80	66	2,0	70	105					95x1/6	0,74
	80	90	81	2,0	85	116					110x1/4	1,06
	100	100	100	2,0	104	130					130x1/4	1,50
	125	187,5	125	2,0	129	223					160x1/4	1,75
	150	225	150	2,0	154	265					190x1/4	2,01

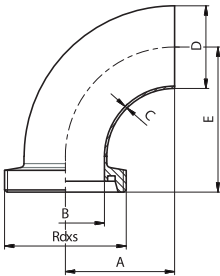

Bend 90° K - S Bogen 90° K - S	30050	Dimensions • Baumaße										
		DN	A	B	C	D	E	F	R	L	Rd x s	kg
	10	26	10	1,5	13	40						0,04
	15	35	16	1,5	19	49						0,06
	20	40	20	1,5	23	56						0,10
	25	50	26	1,5	29	68						0,16
	32	55	32	1,5	35	73						0,20
	40	60	38	1,5	41	78						0,34
	50	70	50	1,5	53	89						0,40
	65	80	66	2,0	70	101						0,72
	80	90	81	2,0	85	111						1,04
	100	100	100	2,0	104	125						1,48
	125	187,5	125	2,0	129	214,5						1,73
	150	225	150	2,0	154	254						1,89

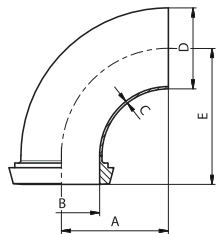

Bend 90° G - G Bogen 90° G - G	30060	Dimensions • Baumaße										
		DN	A	B	C	D	E	F	R	L	Rd x s	kg
	10	43	10	1,5							28x1/8	0,10
	15	52	16	1,5							34x1/8	0,15
	20	59	20	1,5							44x1/6	0,26
	25	72	26	1,5							52x1/6	0,35
	32	77	32	1,5							58x1/6	0,41
	40	82	38	1,5							65x1/6	0,51
	50	93	50	1,5							78x1/6	0,72
	65	105	66	2,0							95x1/6	1,06
	80	116	81	2,0							110x1/4	1,73
	100	130	100	2,0							130x1/4	2,18
	125	223	125	2,0							160x1/4	4,21
	150	265	150	2,0							190x1/4	6,66

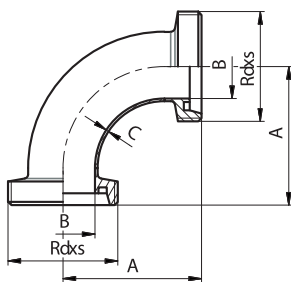

Bend 90° K/M - G Bogen 90° K/M - G	30070	Dimensions • Baumaße										
		DN	A	B	C	D	E	F	R	L	Rd x s	kg
	10	40	10	1,5		43					28x1/8	0,16
	15	49	16	1,5		52					34x1/8	0,21
	20	56	20	1,5		59					44x1/6	0,34
	25	68	26	1,5		72					52x1/6	0,47
	32	73	32	1,5		77					58x1/6	0,57
	40	78	38	1,5		82					65x1/6	0,70
	50	89	50	1,5		93					78x1/6	0,97
	65	101	66	2,0		105					95x1/6	1,52
	80	111	81	2,0		115					110x1/4	2,23
	100	125	100	2,0		130					130x1/4	3,01
	125	214,5	125	2,0		223					160x1/4	4,21
	150	254	150	2,0		265					190x1/4	8,01

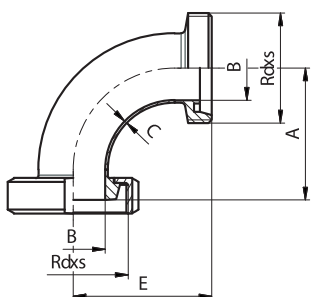

Bend 90° K/M - K/M Bogen 90° K/M - K/M	30080	Dimensions • Baumaße											
		DN	A	B	C	D	E	F	R	L	Rd x s	kg	
		10	40	10	1,5							28x1/8	0,21
		15	49	16	1,5							34x1/8	0,27
		20	56	20	1,5							44x1/6	0,42
		25	68	26	1,5							52x1/6	0,63
		32	73	32	1,5							58x1/6	0,73
		40	78	38	1,5							65x1/6	0,87
		50	89	50	1,5							78x1/6	1,23
		65	101	66	2,0							95x1/6	1,99
		80	111	81	2,0							110x1/4	2,73
		100	125	100	2,0							130x1/4	3,84
		125	214,5	125	2,0							160x1/4	6,37
		150	254	150	2,0							190x1/4	9,36

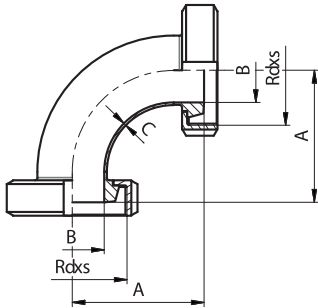

Bend 90° C - C Bogen 90° C - C	30090	Dimensions • Baumaße											
		DN	A	B	C	D	E	F	r	L	Rd x s	kg	
		10	38,7	10	1,5		34						0,08
		15	47,7	16	1,5		34						0,09
		20	52,7	20	1,5		34						0,10
		25	62,7	26	1,5		50,5						0,20
		32	67,7	32	1,5		50,5						0,23
		40	72,7	38	1,5		50,5						0,28
		50	82,7	50	1,5		64						0,32
		65	92,7	66	2,0		91						0,62
		80	102,7	81	2,0		106						0,92
		100	115,8	100	2,0		119						1,13

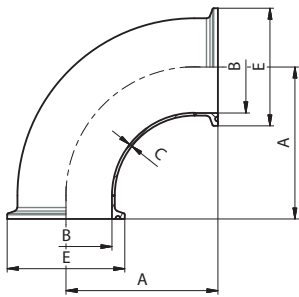

Bend 90° C - S Bogen 90° C - S	30091	Dimensions • Baumaße											
		DN	A	B	C	D	E	F	r	L	Rd x s	kg	
		10		10	1,5	13	34						0,04
		15		16	1,5	19	34						0,05
		20		20	1,5	23	34						0,06
		25		26	1,5	29	50,5						0,08
		32		32	1,5	35	50,5						0,10
		40		38	1,5	41	50,5						0,11
		50		50	1,5	53	64						0,15
		65		66	2,0	70	91						0,34
		80		81	2,0	85	106						0,46
		100		100	2,0	104	119						0,56

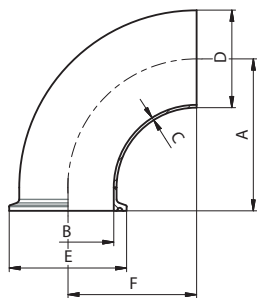

Bend 45° S - S Bogen 45° S - S	30100	Dimensions • Baumaße											
		DN	A	B	C	D	E	F	R	L	Rd x s	kg	
		10			1,5	12							0,01
		10			1,5	13							0,01
		15			1,5	18							0,02
		15			1,5	19							0,02
		20			1,5	22							0,02
		20			1,5	23							0,02
		25			1,5	28							0,04
		25			1,5	29							0,04
		32			1,5	34							0,05
		32			1,5	35							0,05
		40			1,5	40							0,07
		40			1,5	41							0,07
		50			1,5	52							0,10
		50			1,5	53							0,10
		65			2,0	70							0,21
		80			2,0	85							0,30
		100			2,0	104							0,40
		125			2,0	129							0,95
		150			2,0	154							1,40

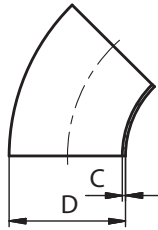

Bend 45° G - S Bogen 45° G - S	30130	Dimensions • Baumaße											
		DN	A	B	C	D	E	F	R	L	Rd x s	kg	
		10		10	1,5	13						28x1/8	0,05
		15		16	1,5	19						34x1/8	0,07
		20		20	1,5	23						44x1/6	0,13
		25		26	1,5	29						52x1/6	0,17
		32		32	1,5	35						58x1/6	0,21
		40		38	1,5	41						65x1/6	0,25
		50		50	1,5	53						78x1/6	0,35
		65		66	2,0	70						95x1/6	0,58
		80		81	2,0	85						110x1/4	0,86
		100		100	2,0	104						130x1/4	1,09
		125		125	2,0	129						160x1/4	2,10
		150		150	2,0	154						190x1/4	3,33

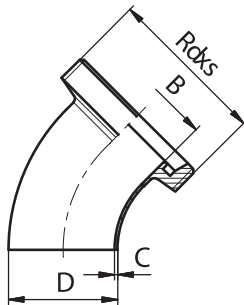

Bend 45° K - S Bogen 45° K - S	30140	Dimensions • Baumaße											
		DN	A	B	C	D	E	F	R	L	Rd x s	kg	
		10		10	1,5	13	22,5						0,03
		15		16	1,5	19	28,5						0,04
		20		20	1,5	23	36,5						0,08
		25		26	1,5	29	44						0,12
		32		32	1,5	35	50						0,15
		40		38	1,5	41	56						0,18
		50		50	1,5	53	68,5						0,26
		65		66	2,0	70	86						0,47
		80		81	2,0	85	100						0,58
		100		100	2,0	104	121						0,87
		125		125	2,0	129	150						1,66
		150		150	2,0	154	176						2,31

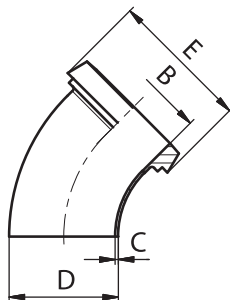

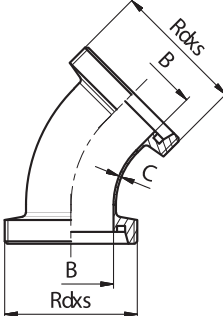
Bend 45° G - G Bogen 45° G - G	30150	Dimensions • Baumaße										
		DN	A	B	C	D	E	F	R	L	Rd x s	kg
	10		10	1,5							28x1/8	0,09
	15		16	1,5							34x1/8	0,13
	20		20	1,5							44x1/6	0,24
	25		26	1,5							52x1/6	0,31
	32		32	1,5							58x1/6	0,36
	40		38	1,5							65x1/6	0,44
	50		50	1,5							78x1/6	0,60
	65		66	2,0							95x1/6	0,95
	80		81	2,0							110x1/4	1,43
	100		100	2,0							130x1/4	1,77
	125		125	2,0							160x1/4	3,26
	150		150	2,0							190x1/4	5,31

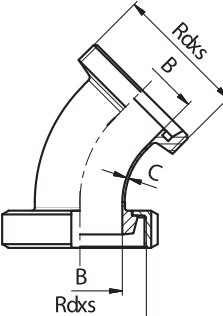
Bend 45° K/M - G Bogen 45° K/M - G	30160	Dimensions • Baumaße										
		DN	A	B	C	D	E	F	R	L	Rd x s	kg
	10		10	1,5							28x1/8	0,15
	15		16	1,5							34x1/8	0,19
	20		20	1,5							44x1/6	0,32
	25		26	1,5							52x1/6	0,43
	32		32	1,5							58x1/6	0,52
	40		38	1,5							65x1/6	0,62
	50		50	1,5							78x1/6	0,86
	65		66	2,0							95x1/6	1,41
	80		81	2,0							110x1/4	1,93
	100		100	2,0							130x1/4	2,61
	125		125	2,0							160x1/4	4,34
	150		150	2,0							190x1/4	6,66

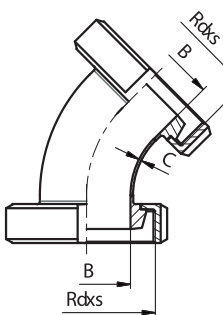
Bend 45° K/M - K/M Bogen 45° K/M - K/M	30170	Dimensions • Baumaße										
		DN	A	B	C	D	E	F	R	L	Rd x s	kg
	10		10	1,5							28x1/8	0,20
	15		16	1,5							34x1/8	0,25
	20		20	1,5							44x1/6	0,40
	25		26	1,5							52x1/6	0,56
	32		32	1,5							58x1/6	0,67
	40		38	1,5							65x1/6	0,81
	50		50	1,5							78x1/6	1,12
	65		66	2,0							95x1/6	1,88
	80		81	2,0							110x1/4	2,43
	100		100	2,0							130x1/4	3,44
	125		125	2,0							160x1/4	5,43
	150		150	2,0							190x1/4	8,01

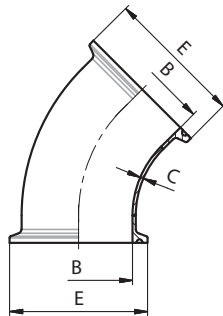
Bend 45° C - C Bogen 45° C - C	30190	Dimensions • Baumaße									
		DN	A	B	C	D	E	F	R	L	Rd x s
	10		10	1,5		34					0,07
	15		16	1,5		34					0,08
	20		20	1,5		34					0,10
	25		26	1,5		50,5					0,12
	32		32	1,5		50,5					0,15
	40		38	1,5		50,5					0,15
	50		50	1,5		64					0,20
	65		66	2,0		91					0,47
	80		81	2,0		106					0,62
	100		100	2,0		119					0,72

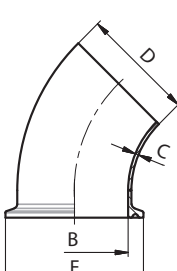
Bend 45° S - C Bogen 45° S - C	30191	Dimensions • Baumaße									
		DN	A	B	C	D	E	F	R	L	Rd x s
	10		10	1,5	13	34					0,04
	15		16	1,5	19	34					0,05
	20		20	1,5	23	34					0,06
	25		26	1,5	29	50,5					0,08
	32		32	1,5	35	50,5					0,10
	40		38	1,5	41	50,5					0,11
	50		50	1,5	53	64					0,15
	65		66	2,0	70	91					0,34
	80		81	2,0	85	106					0,46
	100		100	2,0	104	119					0,56

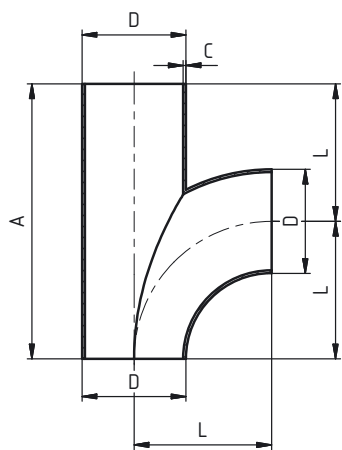
Tee bend S - S - S T - Bogen S - S - S	30300	Dimensions • Baumaße										
		DN	A	B	C	D	E	F	R	L	Rd x s	kg
		15	70		1,5	18				35		0,07
		15	70		1,5	19				35		0,07
		20	80		1,5	22				40		0,08
		20	80		1,5	23				40		0,08
		25	100		1,5	28				50		0,14
		25	100		1,5	29				50		0,14
		32	110		1,5	34				55		0,18
		32	110		1,5	35				55		0,18
		40	120		1,5	40				60		0,23
		40	120		1,5	41				60		0,23
		50	140		1,5	52				70		0,34
		50	140		1,5	53				70		0,34
		65	160		2,0	70				80		0,51
		80	180		2,0	85				90		0,91
		100	200		2,0	104				100		1,21
		125	375		2,0	129				187,5		3,14
		150	450		2,0	154				225		5,38

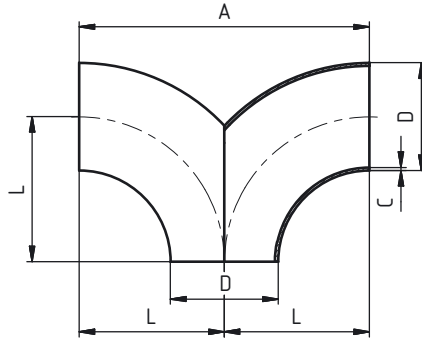
Double tee bend S - S - S T - Doppelbogen S - S - S	30320	Dimensions • Baumaße										
		DN	A	B	C	D	E	F	R	L	Rd x s	kg
		15	70		1,5	18				35		0,06
		15	70		1,5	19				35		0,06
		20	80		1,5	22				40		0,08
		20	80		1,5	23				40		0,08
		25	100		1,5	28				50		0,15
		25	100		1,5	29				50		0,15
		32	110		1,5	34				55		0,20
		32	110		1,5	35				55		0,20
		40	120		1,5	40				60		0,26
		40	120		1,5	41				60		0,26
		50	140		1,5	52				70		0,40
		50	140		1,5	53				70		0,40
		65	160		2,0	70				80		0,81
		80	180		2,0	85				90		1,12
		100	200		2,0	104				100		1,52
		125	375		2,0	129				187,5		3,62
		150	450		2,0	154				225		5,22

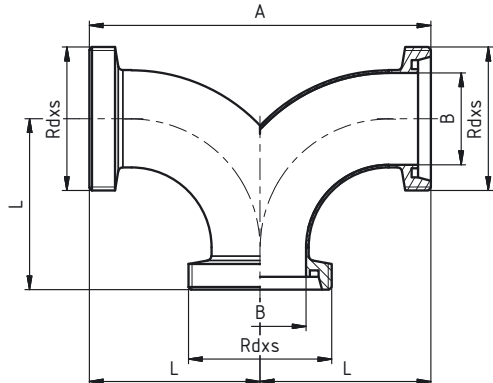
Double tee bend G - G - G T - Doppelbogen G - G - G	30330	Dimensions • Baumaße									
		DN	A	B	C	D	E	F	L	Rd x s	kg
		25	144	26	1,5				72	52x1/6	0,55
		32	154	32	1,5				77	58x1/6	0,66
		40	164	38	1,5				82	65x1/6	0,82
		50	186	50	1,5				93	78x1/6	1,14
		65	210	66	2,0				105	95x1/6	1,92
		80	230	81	2,0				116	110x1/4	2,83
		100	260	100	2,0				130	130x1/4	3,57
		125	446	125	2,0				223	160x1/4	7,11
		150	530	150	2,0				265	190x1/4	11,15

Bend 180° S - S Bogen 180° S - S	30340	Dimensions • Baumaße										
		DN	A	B	C	D	E	F	R	L	Rd x s	kg
		10	52		1,5	12				26		0,04
		15	70		1,5	18				35		0,08
		20	80		1,5	22				40		0,08
		25	100		1,5	28				50		0,16
		32	112		1,5	34				56		0,20
		40	126		1,5	40				63		0,40
		50	144		1,5	52				72		0,40
		65	170		2,0	70				85		0,80
		80	186		2,0	85				93		1,12
		100	220		2,0	104				110		1,52

rozměry řada 2 na vyžádání

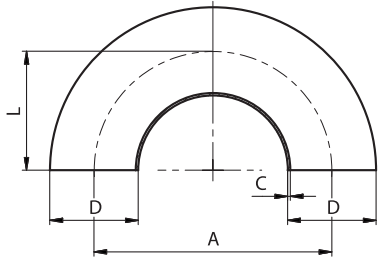

Bend 180° G - G Bogen 180° G - G	30350	Dimensions • Baumaße										
		DN	A	B	C	D	E	F	R	L	Rd x s	kg
		10	52	10						43	28x1/8	0,12
		15	70	16						52	34x1/8	0,18
		20	80	20						59	44x1/6	0,31
		25	100	26						72	52x1/6	0,43
		32	112	32						77	58x1/6	0,52
		40	126	38						82	65x1/6	0,65
		50	144	50						93	78x1/6	0,92
		65	170	66						105	95x1/6	1,39
		80	186	81						116	110x1/4	2,32
		100	220	100						130	130x1/4	2,98
		125	375	125						223	160x1/4	6,09
		150	450	150						265	190x1/4	9,37

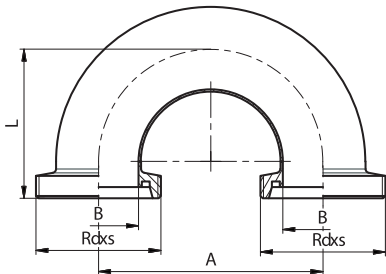

Bend 180° K/M - K/M Bogen 180° K/M - K/M	30360	Dimensions • Baumaße										
		DN	A	B	C	D	E	F	R	L	Rd x s	kg
		10	52	10						40	28x1/8	0,23
		15	70	16						49	34x1/8	0,31
		20	80	20						56	44x1/6	0,48
		25	100	26						68	52x1/6	0,54
		32	112	32						73	58x1/6	0,83
		40	126	38						78	65x1/6	1,02
		50	144	50						89	78x1/6	1,44
		65	170	66						101	95x1/6	2,31
		80	186	81						111	110x1/4	3,32
		100	220	100						125	130x1/4	4,65
		125	375	125						214,5	160x1/4	8,25
		150	450	150						254	190x1/4	12,07

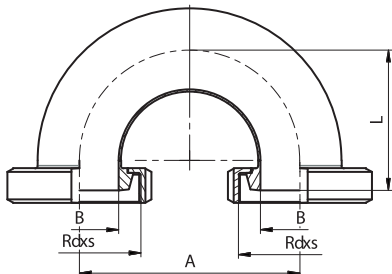

Tee S - S - S (short) T - Stück S - S - S (kurz)	30400	Dimensions • Baumaße										
		DN	A	A1	C	D	E	F	R	L	Rd x s	kg
		10	26	8	1,5	12						0,02
		10	26	8	1,5	13						0,02
		15	35	11	1,5	18						0,04
		15	35	11	1,5	19						0,04
		20	40	13	1,5	22						0,06
		20	40	13	1,5	23						0,06
		25	50	16	1,5	28						0,10
		25	50	16	1,5	29						0,10
		32	55	18	1,5	34						0,13
		32	55	18	1,5	35						0,13
		40	60	23	1,5	40						0,17
		40	60	23	1,5	41						0,17
		50	70	29	1,5	52						0,26
		50	70	29	1,5	53						0,26
		65	80	38	2,0	70						0,53
		80	90	45,5	2,0	85						0,72
		100	100	55	2,0	104						0,98
		125	187,5	66,5	2,0	129						2,32
		150	225	79	2,0	154						3,32

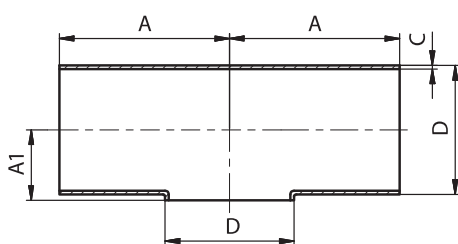

Tee S - S - S (reducing)
T - Stück S - S - S (reduziert)

30440

Dimensions • Baumaße

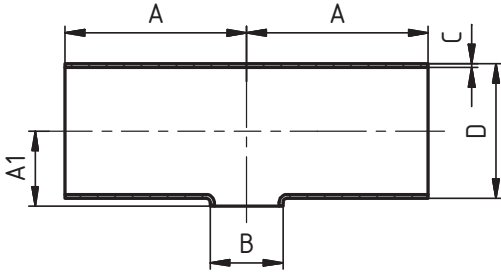

DN	A	A1	B	C	D	kg	DN	A	A1	B	C	D	kg
15/10	35	11	12	1,5	18		65/40	80	38	41	2	70	
15/10	35	11	13	1,5	19		65/50	80	38	52	2	70	
20/10	40	13	12	1,5	22		65/50	80	38	53	2	70	
20/10	40	13	13	1,5	23		65/50	80	38	54	2	70	
20/15	40	13	18	1,5	22		80/15	90	46	18	2	85	
20/15	40	13	19	1,5	23		80/15	90	46	19	2	85	
25/10	50	16	12	1,5	28		80/20	90	46	22	2	85	
25/10	50	16	13	1,5	29		80/20	90	46	23	2	85	
25/15	50	16	18	1,5	28		80/25	90	46	28	2	85	
25/15	50	16	19	1,5	29		80/25	90	46	29	2	85	
25/20	50	16	22	1,5	28		80/32	90	46	34	2	85	
25/20	50	16	23	1,5	29		80/32	90	46	35	2	85	
32/10	55	19	12	1,5	34		80/40	90	46	40	2	85	
32/10	55	19	13	1,5	35		80/40	90	46	41	2	85	
32/15	55	19	18	1,5	34		80/50	90	46	52	2	85	
32/15	55	19	19	1,5	35		80/50	90	46	53	2	85	
32/20	55	19	22	1,5	34		80/65	90	46	70	2	85	
32/20	55	19	23	1,5	35		100/25	100	55	28	2	104	
32/25	55	19	28	1,5	34		100/25	100	55	29	2	104	
32/25	55	19	29	1,5	35		100/32	100	55	34	2	104	
40/10	60	22	12	1,5	40		100/32	100	55	35	2	104	
40/10	60	22	13	1,5	41		100/40	100	55	40	2	104	
40/15	60	22	18	1,5	40		100/40	100	55	41	2	104	
40/15	60	22	19	1,5	41		100/50	100	55	52	2	104	
40/20	60	22	22	1,5	40		100/50	100	55	53	2	104	
40/20	60	22	23	1,5	41		100/65	100	55	70	2	104	
40/25	60	22	28	1,5	40		100/80	100	55	85	2	104	
40/25	60	22	29	1,5	41		125/25	187,5	66,5	28	2	129	
40/32	60	22	34	1,5	40		125/25	187,5	66,5	29	2	129	
40/32	60	22	35	1,5	41		125/32	187,5	66,5	34	2	129	
50/10	70	28	12	1,5	52		125/32	187,5	66,5	35	2	129	
50/10	70	28	13	1,5	53		125/40	187,5	66,5	40	2	129	
50/15	70	28	18	1,5	52		125/40	187,5	66,5	41	2	129	
50/15	70	28	19	1,5	53		125/50	187,5	66,5	52	2	129	
50/20	70	28	22	1,5	52		125/50	187,5	66,5	53	2	129	
50/20	70	28	23	1,5	53		125/65	187,5	66,5	70	2	125	
50/25	70	28	28	1,5	52		125/80	187,5	66,5	85	2	125	
50/25	70	28	29	1,5	53		125/100	187,5	66,5	104	2	125	
50/32	70	28	34	1,5	52		150/25	225	79	28	2	154	
50/32	70	28	35	1,5	53		150/25	225	79	29	2	154	
50/40	70	28	40	1,5	52		150/32	225	79	34	2	154	
50/40	70	28	41	1,5	53		150/32	225	79	35	2	154	
65/15	80	38	18	2	70		150/40	225	79	40	2	154	
65/15	80	38	19	2	70		150/40	225	79	41	2	154	
65/20	80	38	22	2	70		150/50	225	79	52	2	154	
65/20	80	38	23	2	70		150/50	225	79	53	2	154	
65/25	80	38	28	2	70		150/65	225	79	70	2	154	
65/25	80	38	29	2	70		150/80	225	79	84	2	154	
65/32	80	38	34	2	70		150/80	225	79	85	2	154	
65/32	80	38	35	2	70		150/100	225	79	104	2	154	
65/40	80	38	40	2	70		150/125	225	79	129	2	154	

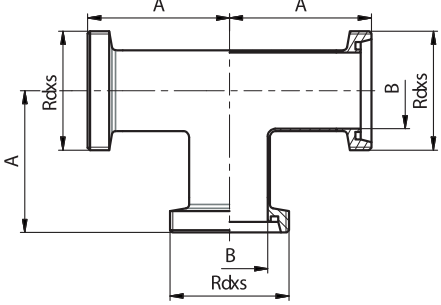
Tee G - G - G T - Stück G - G - G	30450	Dimensions • Baumaße										
		DN	A	B	C	D	E	F	R	L	Rd x s	kg
	10	43	10								28x1/8	0,16
	15	52	16								34x1/8	0,23
	20	59	20								44x1/6	0,40
	25	72	26								52x1/6	0,53
	32	77	32								58x1/6	0,64
	40	82	38								65x1/6	0,79
	50	93	50								78x1/6	1,08
	65	105	66								95x1/6	1,78
	80	116	81								110x1/4	2,62
	100	130	100								130x1/4	3,26
	125	223	125								160x1/4	6,57
150	265	150								190x1/4	10,38	

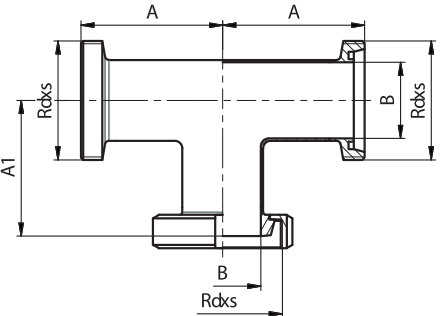
Tee G - G - K/M T - Stück G - G - K/M	30460	Dimensions • Baumaße										
		DN	A	A1	B	D	E	F	R	L	Rd x s	kg
	10	43	40	10							28x1/8	0,21
	15	52	49	16							34x1/8	0,29
	20	59	56	20							44x1/6	0,48
	25	72	68	26							52x1/6	0,62
	32	77	73	32							58x1/6	0,80
	40	82	78	38							65x1/6	0,97
	50	93	89	50							78x1/6	1,35
	65	105	101	66							95x1/6	2,24
	80	116	111	81							110x1/4	3,11
	100	130	125	100							130x1/4	4,10
	125	223	214,5	125							160x1/4	7,65
150	265	254	150							190x1/4	9,34	

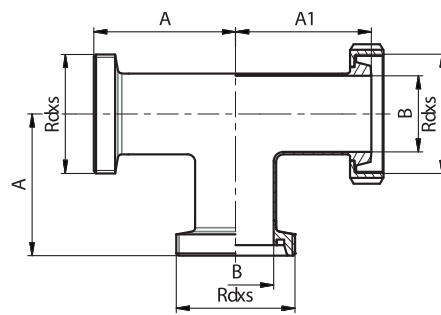
Tee G - K/M - G T - Stück G - K/M - G	30470	Dimensions • Baumaße										
		DN	A	A1	B	D	E	F	R	L	Rd x s	kg
	10	43	40	10							28x1/8	0,21
	15	52	49	16							34x1/8	0,29
	20	59	56	20							44x1/6	0,48
	25	72	68	26							52x1/6	0,62
	32	77	73	32							58x1/6	0,80
	40	82	78	38							65x1/6	0,97
	50	93	89	50							78x1/6	1,35
	65	105	101	66							95x1/6	2,24
	80	116	111	81							110x1/4	3,11
	100	130	125	100							130x1/4	4,10
	125	223	214,5	125							160x1/4	7,65
150	265	254	150							190x1/4	9,34	

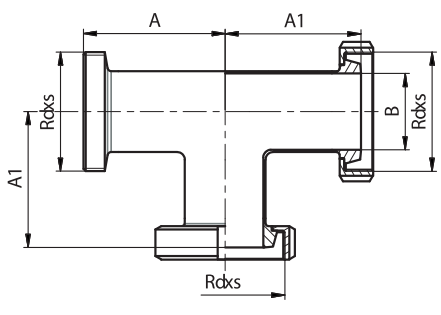
Tee G - K/M - K/M T - Stück G - K/M - K/M	30480	Dimensions • Baumaße										
		DN	A	A1	B	D	E	F	R	L	Rd x s	kg
	10	43	40	10							28x1/8	0,27
	15	52	49	16							34x1/8	0,35
	20	59	56	20							44x1/6	0,56
	25	72	68	26							52x1/6	0,79
	32	77	73	32							58x1/6	0,95
	40	82	78	38							65x1/6	1,16
	50	93	89	50							78x1/6	1,60
	65	105	101	66							95x1/6	2,70
	80	116	111	81							110x1/4	3,61
	100	130	125	100							130x1/4	4,93
	125	223	214,5	125							160x1/4	8,73
150	265	254	150							190x1/4	13,06	

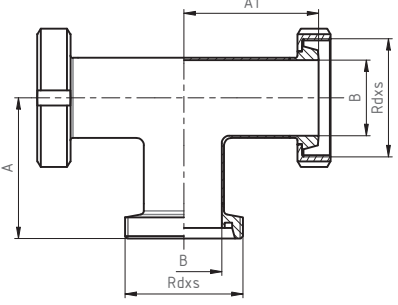
Tee K/M - K/M - G T - Stück K/M - K/M - G	30490	Dimensions • Baumaße										
		DN	A	A1	B	D	E	F	R	L	Rd x s	kg
	10	43	40	10							28x1/8	0,27
	15	52	49	16							34x1/8	0,35
	20	59	56	20							44x1/6	0,56
	25	72	68	26							52x1/6	0,79
	32	77	73	32							58x1/6	0,95
	40	82	78	38							65x1/6	1,16
	50	93	89	50							78x1/6	1,60
	65	105	101	66							95x1/6	2,70
	80	115	111	81							110x1/4	3,61
	100	130	125	100							130x1/4	4,93
	125	223	214,5	125							160x1/4	8,73
150	265	254	150							190x1/4	13,06	

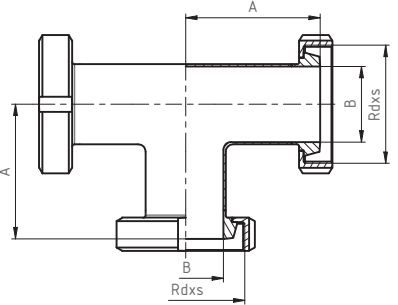
Tee K/M - K/M - K/M T - Stück K/M - K/M - K/M	30500	Dimensions • Baumaße										
		DN	A	B	C	D	E	F	R	L	Rd x s	kg
	10	40	10								28x1/8	0,32
	15	49	16								34x1/8	0,41
	20	56	20								44x1/6	0,64
	25	68	26								52x1/6	0,92
	32	73	32								58x1/6	1,11
	40	78	38								65x1/6	1,34
	50	89	50								78x1/6	1,86
	65	101	66								95x1/6	3,17
	80	111	81								110x1/4	4,11
	100	125	100								130x1/4	5,76
	125	214,5	125								160x1/4	9,81
150	254	150								190x1/4	14,41	

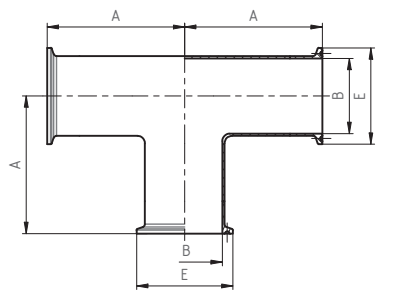
Tee C - C - C (long) T - Stück C - C - C (lang)	30520	Dimensions • Baumaße										
		DN	A	B	C	D	E	F	R	L	Rd x s	kg
	10	38,7	10			34						0,13
	15	47,7	16			34						0,15
	20	52,7	20			50,5						0,16
	25	62,7	26			50,5						0,34
	32	67,7	32			50,5						0,40
	40	72,7	38			50,5						0,40
	50	82,7	50			64						0,54
	65	92,7	66			91						1,24
	80	102,7	81			106						1,59
	100	115,8	100			119						1,88
	125	203,3	125			155						4,64
150	240,8	150			183						6,53	

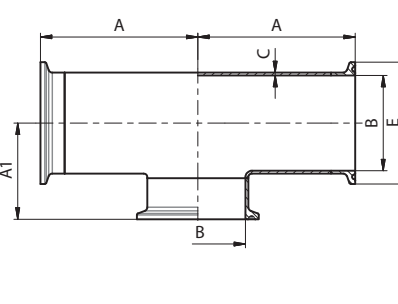
Tee C - C - C (short) T - Stück C - C - C (kurz)	30521	Dimensions • Baumaße										
		DN	A	A1	B	C	E	F	R	L	Rd x s	kg
	10	38,7	26	10	1,5	34						0,13
	15	47,7	29	16	1,5	34						0,15
	20	52,7	31	20	1,5	50,5						0,16
	25	62,7	37,5	26	1,5	50,5						0,34
	32	67,7	39,5	32	1,5	50,5						0,40
	40	72,7	44,5	38	1,5	50,5						0,40
	50	82,7	50,5	50	1,5	64						0,54
	65	92,7	66	66	2,0	91						1,24
	80	102,7	73,5	81	2,0	106						1,59
	100	112,7	80	100	2,0	119						1,88

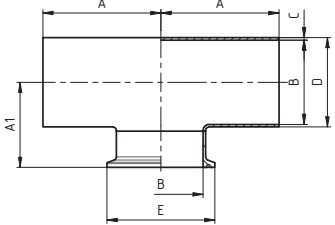
Tee S - S - C (short) T - Stück S - S - C (kurz)	30522	Dimensions • Baumaße										
		DN	A	A1	B	C	D	E	F	L	Rd x s	kg
		10	26	26	10	1,5	13	34				0,07
		15	35	29	16	1,5	19	34				0,09
		20	40	31	20	1,5	23	34				0,10
		25	50	37,5	26	1,5	29	50,5				0,28
		32	55	39,5	32	1,5	35	50,5				0,34
		40	60	44,5	38	1,5	41	50,5				0,34
		50	70	50,5	50	1,5	53	64				0,48
		65	80	66	66	2,0	70	91				1,18
		80	90	73,5	81	2,0	85	106				1,53
		100	100	80	100	2,0	104	119				1,82

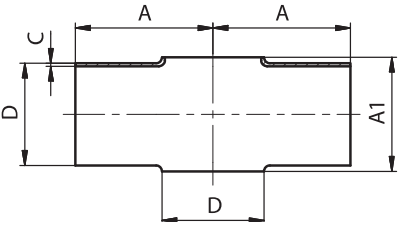
Cross piece S - S - S - S (short) Kreuzstück S - S - S - S (kurz)	30540	Dimensions • Baumaße										
		DN	A	A1	C	D	E	F	R	L	Rd x s	kg
		25	50	30	1,5	28						0,09
		25	50	30	1,5	29						0,09
		32	55	36	1,5	34						0,13
		32	55	36	1,5	35						0,13
		40	60	44	1,5	40						0,17
		40	60	44	1,5	41						0,17
		50	70	58	1,5	52						0,25
		50	70	58	1,5	53						0,25
		65	80	76	2,0	70						0,51
		80	90	91	2,0	85						0,69
		100	100	110	2,0	104						0,93

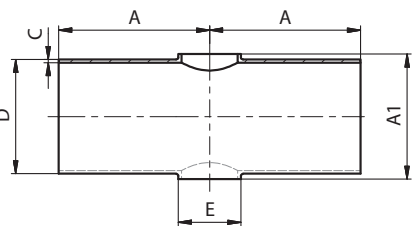
Cross reduced short S - S - S - S Kreuz reduziert kurz S - S - S - S	30550	Dimensions • Baumaße													
		DN	A	A1	C	D	E	kg	DN	A	A1	C	D	E	kg
		15/10	35	22	1,5	19	13	0,03	50/40	70	56	1,5	53	41	0,23
		20/10	40	26	1,5	23	13	0,05	65/25	80	76	2,0	70	29	0,41
		20/15	40	26	1,5	23	19	0,05	65/32	80	76	2,0	70	35	0,44
		25/10	50	32	1,5	29	13	0,07	65/40	80	76	2,0	70	41	0,46
		25/15	50	32	1,5	29	19	0,09	65/50	80	76	2,0	70	53	0,46
		25/20	50	32	1,5	29	23	0,09	80/40	90	92	2,0	85	41	0,64
		32/10	55	38	1,5	35	13	0,10	80/50	90	92	2,0	85	53	0,62
		32/15	55	38	1,5	35	19	0,10	80/65	90	92	2,0	85	70	0,75
		32/20	55	38	1,5	35	23	0,09	100/50	100	110	2,0	104	53	0,91
		32/25	55	38	1,5	35	29	0,09	100/65	100	110	2,0	104	70	0,89
		40/15	60	44	1,5	41	19	0,13	100/80	100	110	2,0	104	85	0,81
		40/20	60	44	1,5	41	23	0,13	125/65	187,5	133	2,0	129	70	2,19
		40/25	60	44	1,5	41	29	0,14	125/80	187,5	133	2,0	129	85	2,01
		40/32	60	44	1,5	41	35	0,14	125/100	187,5	133	2,0	129	104	1,85
		50/20	70	56	1,5	53	23	0,22	150/80	225	158	2,0	154	85	3,03
		50/25	70	56	1,5	53	29	0,23	150/100	225	158	2,0	154	104	2,85
		50/32	70	56	1,5	53	35	0,23	150/125	225	158	2,0	154	129	2,63

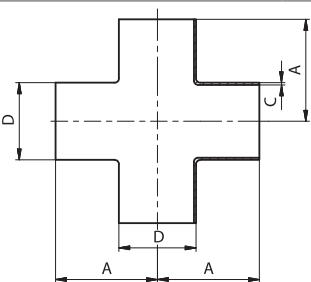
Cross piece S - S - S - S (long) Kreuzstück S - S - S - S (lang)	30560	Dimensions • Baumaße										
		DN	A	B	C	D	E	F	R	L	Rd x s	kg
		25	50		1,5	28						0,18
		25	50		1,5	29						0,18
		32	55		1,5	34						0,22
		32	55		1,5	35						0,22
		40	60		1,5	40						0,28
		40	60		1,5	41						0,28
		50	70		1,5	52						0,42
		50	70		1,5	53						0,42
		65	80		2,0	70						0,80
		80	90		2,0	85						1,01
		100	100		2,0	104						1,39

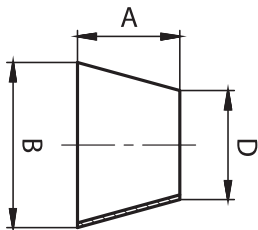
Reducing piece concentric S - S Reduzierstück konzentrisch S - S	30600	Dimensions • Baumaße				
		DN	A	B	D	kg
		15/10	11	19	13	0,01
		20/10	18	23	13	0,01
		20/15	7	23	19	0,01
		25/15	18	29	19	0,02
		25/20	11	29	23	0,01
		32/20	22	35	23	0,02
		32/25	11	35	29	0,01
		40/20	33	41	23	0,02
		40/25	22	41	29	0,03
		40/32	11	41	35	0,01
		50/25	44	53	29	0,06
		50/32	33	53	35	0,05
		50/40	23	53	41	0,04

DN	A	B	D	kg
65/40	52	70	41	0,12
65/50	30	70	53	0,08
80/50	56	85	53	0,20
80/65	27	85	70	0,11
100/65	60	104	70	0,26
100/80	35	104	85	0,16
125/80	79	129	85	0,42
125/100	45	129	104	0,27
150/100	90	154	104	0,60
150/125	45	154	129	0,33
200/150	90	204	154	0,80
250/150	297	253	154	2,90

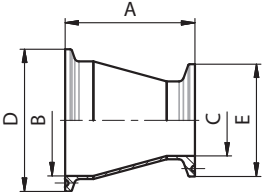
Reducing piece concentric C - C Reduzierstück konzentrisch C - C	30609	Dimensions • Baumaße										
		DN	A	B	C	D	E	F	R	L	Rd x s	kg
		32/25	36,4	32	26	50,5	50,5					0,11
		40/25	47,4	38	26	50,5	50,5					0,11
		40/32	36,4	38	32	50,5	50,5					0,11
		50/25	69,4	50	26	64	50,5					0,14
		50/32	58,4	50	32	64	50,5					0,15
		50/40	48,4	50	38	64	50,5					0,13
		65/40	77,4	66	38	91	50,5					0,31
		65/50	55,4	66	50	91	64					0,18
		80/50	81,4	81	50	106	64					0,40
		80/65	52,4	81	66	106	91					0,39
		100/65	88,5	100	66	119	91					0,55
		100/80	63,5	100	81	119	106					0,48

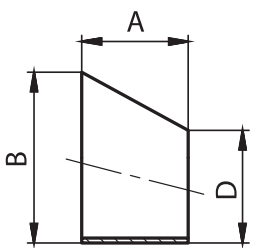
Reducing piece eccentric S - S Reduzierstück exzentrisch S - S	30610	Dimensions • Baumaße										
		DN	A	B	C	D	E	F	R	L	Rd x s	kg
		32/25	16,5	35		29						0,02
		40/25	33	41		29						0,03
		40/32	16,5	41		35						0,02
		50/25	44	53		29						0,05
		50/32	33	53		35						0,05
		50/40	33	53		41						0,04
		65/40	51	70		41						0,14
		65/50	44	70		53						0,09
		80/50	56	85		53						0,19
		80/65	41,2	85		70						0,10
		100/65	61	104		70						0,26
		100/80	52,5	104		85						0,16

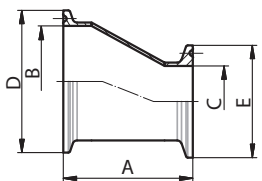
Reducing piece eccentric C - C Reduzierstück exzentrisch C - C	30619	Dimensions • Baumaße										
		DN	A	B	C	D	E	F	R	L	Rd x s	kg
		32/25	41,9	32	26	50,5	50,5					0,11
		40/25	58,4	38	26	50,5	50,5					0,11
		40/32	41,9	38	32	50,5	50,5					0,11
		50/25	69,4	50	26	64	50,5					0,14
		50/32	58,4	50	32	64	50,5					0,15
		50/40	58,4	50	38	64	50,5					0,13
		65/40	76,4	66	38	91	50,5					0,31
		65/50	69,4	66	50	91	64					0,18
		80/50	81,4	81	50	106	64					0,40
		80/65	66,6	81	66	106	91					0,39
		100/65	89,5	100	66	119	91					0,55
		100/80	81	100	81	119	106					0,48

Reducing piece concentric S - S (long) Reduzierstück konzentrisch S - S (lang)	30620	Dimensions • Baumaße										
		DN	A	A1	B	C	D	F	R	L	Rd x s	kg
	15/10	45	18	18	1,5	12						0,02
	20/10	63	18	22	1,5	12						0,04
	20/15	60	20	22	1,5	18						0,04
	25/15	60	20	28	1,5	18						0,05
	25/20	60	20	28	1,5	22						0,05
	32/25	80	30	34	1,5	28						0,09
	40/25	102	35	40	1,5	28						0,12
	40/32	88	35	40	1,5	34						0,12
	50/25	115	40	52	1,5	28						0,17
	50/32	129	40	52	1,5	34						0,20
	50/40	113	40	52	1,5	40						0,19
	65/32	125	40	70	2,0	34						0,24
	65/40	120	40	70	2,0	40						0,33
	65/50	130	40	70	2,0	52						0,39
	80/40	140	40	85	2,0	40						0,44
	80/50	125	40	85	2,0	52						0,43
	80/65	120	40	85	2,0	70						0,46
	100/50	160	40	104	2,0	52						0,63
	100/65	127	40	104	2,0	70						0,56
	100/85	120	40	104	2,0	85						0,56

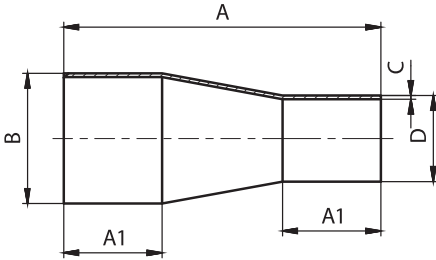

Reducing piece eccentric S - S (long) Reduzierstück exzentrisch S - S (lang)	30630	Dimensions • Baumaße										
		DN	A	A1	B	C	D	F	R	L	Rd x s	kg
	20/15	60	20	22	1,5	18						0,04
	25/15	60	20	28	1,5	18						0,05
	25/20	60	20	28	1,5	22						0,05
	32/25	100	40	34	1,5	28						0,11
	40/25	100	40	40	1,5	28						0,13
	40/32	100	40	40	1,5	34						0,13
	50/25	130	40	52	1,5	28						0,20
	50/32	125	40	52	1,5	34						0,20
	50/40	100	40	52	1,5	40						0,17
	65/40	140	40	70	2,0	40						0,39
	65/50	125	40	70	2,0	52						0,38
	80/50	130	40	85	2,0	52						0,46
	80/65	110	40	85	2,0	70						0,43
	100/65	155	40	104	2,0	70						0,70
	100/85	130	40	104	2,0	85						0,62
	80/50	125	40	85	2,0	52						0,43
	80/65	120	40	85	2,0	70						0,46
	100/50	160	40	104	2,0	52						0,63
	100/65	127	40	104	2,0	70						0,56
	100/85	120	40	104	2,0	85						0,56

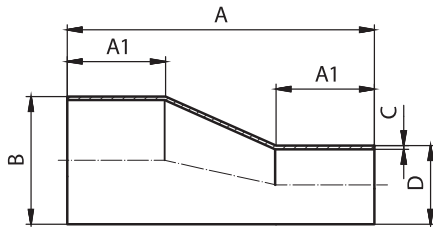

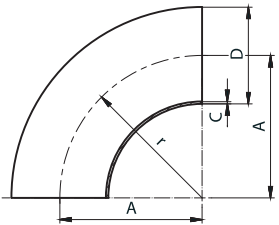
Bend 90° S - S, SMS Bogen 90° S - S, SMS	31010	Dimensions • Baumaße									
	SMS	DN	A	B	C	D	E	r	L	Rd x s	kg
		25	37,5		1,25	25		37,5			0,05
		38	57		1,25	38		57			0,12
		51	76,5		1,25	51		76,5			0,18
		63,5	95,25		1,5	63,5		95,25			0,33
		76	114,15		1,6	76,1		114,15			0,50
		101,6	150		2,0	101,6		150			0,87

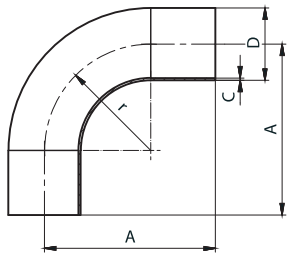
Bend 90° W - W, SMS Bogen 90° W - W, SMS	31020	Dimensions • Baumaße									
	SMS	DN	A	B	C	D	E	r	L	Rd x s	kg
		25	75		1,25	25		38			0,15
		38	90		1,25	38		56			0,21
		51	100		1,25	51		72			0,31
		63,5	115		1,5	63,5		84			0,45
		76	130		1,6	76,1		85			0,67
		101,6	150		2,0	101,6		110			1,27

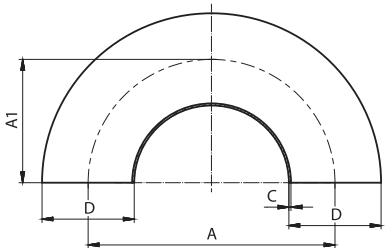
Bend 180° S - S Bogen 180° S - S	31340	Dimensions • Baumaße									
	SMS	DN	A	A1	C	D	E	R	L	Rd x s	kg
		25	75	37,5	1,25	25					0,05
		38	114	57	1,25	38					0,12
		51	153	76,5	1,25	51					0,18
		63,5	190,5	95,25	1,5	63,5					0,33
		76	228,3	114,15	1,6	76,1					0,50
		101,6	304,2	152,1	2,0	101,6					0,87

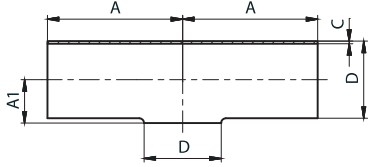
Tee S - S - S, SMS (short) T - Stück S - S - S, SMS (kurz)	31400	Dimensions • Baumaße									
	SMS	DN	A	A1	C	D	E	R	L	Rd x s	kg
	25	55	14	1,25	25						0,11
	38	70	21	1,25	38						0,25
	51	82	28,5	1,25	51						0,47
	63,5	105	36	1,5	63,5						0,75
	76	110	43	1,6	76,1						1,07
	101,6	150	58	2,0	101,6						2,30

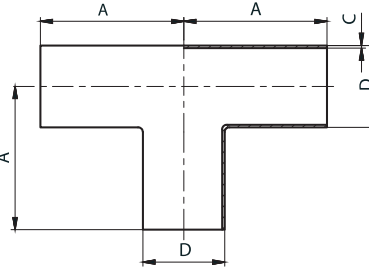
Tee S - S - S, SMS (long) T - Stück S - S - S, SMS (lang)	31410	Dimensions • Baumaße									
	SMS	DN	A	B	C	D	E	R	L	Rd x s	kg
	1" - 25,4	55		1,5	25,4						0,11
	1 1/2" - 38,1	70		1,5	38,1						0,25
	2" - 50,8	82		1,5	50,8						0,47
	2 1/2" - 63,5	105		1,5	63,5						0,75
	3" - 76,1	110		2,0	76,1						1,07
	4" - 101,6	150		2,0	101,6						2,30

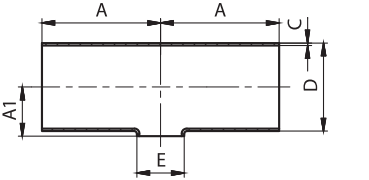
Tee S - S - S, SMS (short) T - Stück S - S - S, SMS (kurz)	31440	Dimensions • Baumaße										
	SMS	DN	A	A1	C	D	E	F	r	L	Rd x s	kg
	38/25	70	21	1,25	38	25						0,17
	51/25	82	29	1,25	51	25						0,26
	51/38	82	29	1,25	51	38						0,27
	63/25	105	34,5	1,5	63,5	25						0,49
	63/38	105	35	1,5	63,5	38						0,51
	63/51	105	36	1,5	63,5	51						0,51
	76/25	110	41	1,6	76,1	25						0,60
	76/38	110	42	1,6	76,1	38						0,68
	76/51	110	43	1,6	76,1	51						0,68
	76/63	110	43	1,6	76,1	63,5						0,81
	101/25	150	56	2,0	101,6	25						0,82
	101/38	150	56	2,0	101,6	38						0,90
	101/51	150	57	2,0	101,6	51						0,95
	101/63	150	58	2,0	101,6	63,5						0,96
	101/76	150	58	2,0	101,6	76,1						0,92

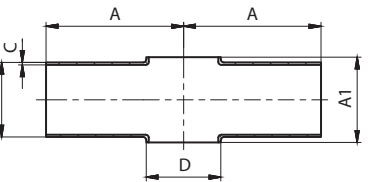
Cross piece S - S - S - S, SMS Kreuzstück S - S - S - S, SMS	31540	Dimensions • Baumaße									
	SMS	DN	A	A1	C	D	E	R	L	Rd x s	kg
	1" - 25,4	55	28	1,5	25,4						0,09
	1 1/2" - 38,1	70	42	1,5	38,1						0,19
	2" - 50,8	82	57	1,5	50,8						0,25
	2 1/2" - 63,5	105	72	1,5	63,5						0,51
	3" - 76,1	110	86	2,0	76,1						0,69
	4" - 101,6	150	116	2,0	101,6						0,93

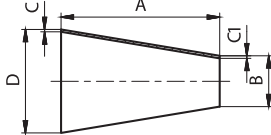
Reducing piece concentric S-S, SMS Reduzierstück konzentrisch S-S, SMS	31600	Dimensions • Baumaße										
	SMS	DN	A	B	C	C1	D	F	R	L	Rd x s	kg
	38/25	39	25	1,2	1,2	38						0,04
	51/25	78	25	1,2	1,2	51						0,09
	51/38	39	38	1,2	1,2	51						0,05
	63/25	116	25	1,5	1,2	63,5						0,20
	63/38	76	38	1,5	1,2	63,5						0,15
	63/51	38	51	1,5	1,2	63,5						0,09
	76/25	153	25	1,6	1,2	76,1						0,23
	76/38	114	38	1,6	1,2	76,1						0,26
	76/51	75	51	1,6	1,2	76,1						0,19
	76/63	38	63,5	1,6	1,5	76,1						0,11
	104/38	198	38	2,0	1,2	104						0,70
	104/51	159	51	2,0	1,2	104						0,61
	104/63	122	63,5	2,0	1,5	104						0,51
	104/76	84	76,1	2,0	1,6	104						0,38

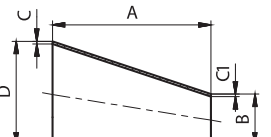
Reducing piece eccentric S-S, SMS Reduzierstück exzentrisch S-S, SMS	31610	Dimensions • Baumaße										
	SMS	DN	A	B	C	C1	D	F	r	L	Rd x s	kg
	38/25	39	25	1,2	1,2	38						0,04
	51/25	78	25	1,2	1,2	51						0,09
	51/38	39	38	1,2	1,2	51						0,05
	63/25	116	25	1,5	1,2	63,5						0,20
	63/38	76	38	1,5	1,2	63,5						0,15
	63/51	38	51	1,5	1,2	63,5						0,09
	76/25	153	25	1,6	1,2	76,1						0,23
	76/38	114	38	1,6	1,2	76,1						0,26
	76/51	75	51	1,6	1,2	76,1						0,19
	76/63	38	63,5	1,6	1,5	76,1						0,11
	104/38	198	38	2,0	1,2	104						0,70
	104/51	159	51	2,0	1,2	104						0,61
	104/63	122	63,5	2,0	1,5	104						0,51
	104/76	84	76,1	2,0	1,6	104						0,38

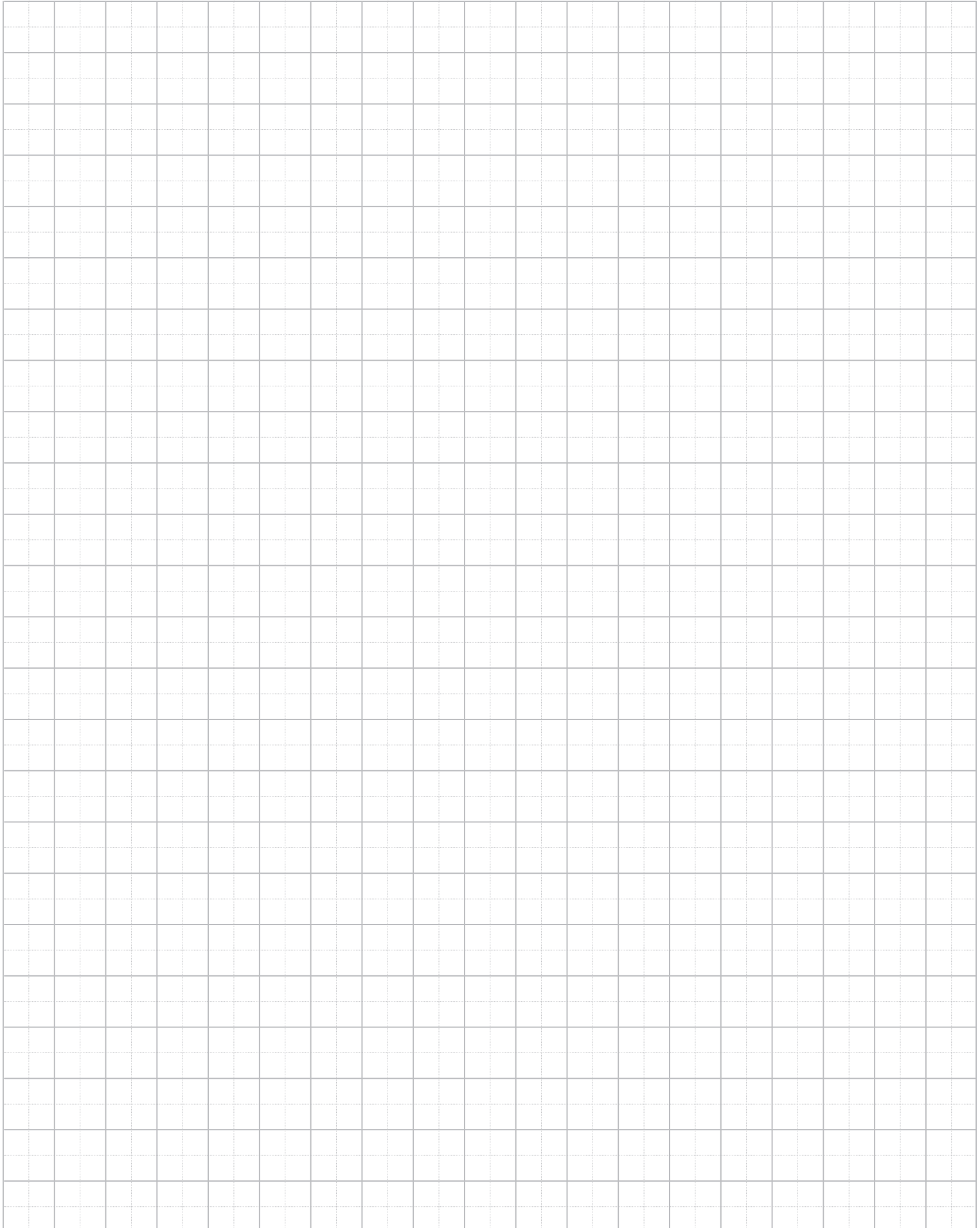

CONVERSION TABLE		UMRECHNUNGSTABELLE	
DN	(inch)	(mm)	
8	1/4"	6,35	
10	3/8"	9,25	
15	1/2"	12,7	
20	3/4"	19,0	
25	1"	25,4	
32	1 1/4"	31,7	
40	1 1/2"	38,1	
50	2"	51,0	
65	2 1/2"	63,5	
80	3"	76,1	
100	4"	104,0	

BAR CONVERSION CHARTS		BAR UMPRECHNUNGSTABELLE	
<h1>1 Bar</h1>		100000 Pascals	
		100 Kilopascals	
		1000 Milibars	
		1000000 Microbars	
		~0,98 Atmospheres	
		~401,46 Inches of wather	
		10 Meters of wather	
		~29,53 Inches of mercury	
		~750 Milimeters of mercury	
		~14,5 Pounds per square inches	
		~1,02 Kilograms per square inches	

MATERIALS USED

All units and parts listed in this catalogue are produced from non-corrosive acid-resistant Cr – Ni steel ČSN 17 240, which is the equivalent of the German standard DIN 1.4301. If the corrosion-proof requirements of the parts are higher they are produced from non-corrosive Cr-Ni-Mo steel ČSN 17 349 which conforms to DIN 1.4404.

Chemical composition of the most frequently used non-corrosive steels

ČSN PN	%C max.	%Si max.	%Mn max.	%P max.	%S max.	%Cr max.	%Mo max.	%Ni max.	%Ti max.
17 240	0.07	1.00	2.00	0.045	0.030	17.0-20.0	-	9.0-11.5	-
17 249	0.03	1.00	2.00	0.045	0.030	17.0-20.0	-	10.0-12.5	-
17 346	0.07	1.00	2.00	0.045	0.030	16.5-18.5	2.0-2.5	10.5-13.5	-
17349	0.03	1.00	2.00	0.045	0.030	16.5-18.5	2.0-2.5	11.0-14.0	-
17 248	0.10	1.00	2.00	0.045	0.030	17.0-19.0	-	9.5-12.0	>=5xC
17 348	0.10	1.00	2.00	0.045	0.030	16.5-18.5	2.0-2.5	11.0-14.0	>=5xC

International standards conversion table for marking steels

Poldi	Czech Rep. PN	Germany DIN (W. Nr.)	USA ASTM	Italy UNI	France AFNOR	Russia GOST
AKV7	17240	1.4301	AISI 304	X5CrNi1810	Z7CN18-09	08Ch18N10
AKV2	17249	1.4306	AISI304L	X2CrNi1811	Z3CN19-121	03Ch18N11
AKV EX7	17346	1.4401	AISI 316	X5CrNiMo1712.2	Z7CND17-12-02	-
AKV EX2	17349	1.4404	AISI 316L	X2CrNiMo1713.2	Z3CND18-12-02	03Ch12N14M2
AKVS7	17248	1.4541	AISI 321	X6CrNiTi1811	Z6CNT18-10	08Ch18N10T
AKV EX S9	17348	1.4571	AISI 316Ti	X6CrNiMoTi1712	Z6CNDT17-12	08Ch17N13M2

DESIGN

The bulk of products are produced from bars or forged material. The material is in such a state that after welding it is not necessary to carry out further treatment. Tubular adapting pipes in their basic finish are pickled – matt, or treated – ground (brushed).

PIPE CONNECTING PARTS – DIN SCREW COUPLINGS

These are produced according to the DIN 11 851 standard and the screw thread according to the DIN 405 (ČSN 01 4037) standard. Connection of the sockets (screw thread or ring) to the tubes can be done in two ways:

- a) butt welding
- b) flaring the inside diameter

From diameters of 50mm and above it is necessary to ensure flaring of connections with a seam weld. Flared connections with a seam weld are hygienically unobjectionable and are suitable for pressures of 1 MPa (tested at a pressure of 2 MPa). Parts which do not correspond to any standards are produced according to branch or factory standards, and possibly workshop standards, and in some cases to approved technical drawings.

SEALING

Seals listed in this catalogue are produced from the following materials – SILICON, PERBUNAN, EPDM or VITON. They are supplied separately or as part of the set. Prices for tubular adapting pipes and sets of screw couplings do not include sealing rings.

MAINTENANCE

Without exception the materials used are suitable for general use in the food-processing industry. These materials are sensitive to high concentrations of chloride solutions and therefore we recommend that the instructions and recommendations of the manufacturer are heeded. Corrosion can only be prevented if these instructions are adhered to.

SPECIAL DESIGN

Apart from the standard parts listed in this catalogue we also supply special designs according to customer requirements and their technical documentation.

INSTRUCTIONS FOR ORDERING

For quick and simple processing of your order please supply the following data:

1	2	3	4
numerical labelling of goods	dimension(DN)	material	amount

If group „3” is not listed in the order we automatically supply material 17 240 (DIN 1.4301)

If you require other parts and units than those in this catalogue please send your specific requirements.

This issue nullifies all previous catalogues and delivery conditions listed in them.

We would be pleased to discuss your specific requirements and answer your questions in person. We look forward to your visit.

Technical Information for Gaskets					
Title	Silicon (VMQ silicon rubber)	EPDM (ethylene-propylene-diene rubber)	Viton (FPM fluorine rubber)	Perbunan (NBR nitrile rubber)	PTFE (polytetrafluorethylene)
Temperature of use	It is stable in water up to 100 °C Possibility of sterilisation by steam short-term up to 120 °C to 130 °C	Permanent operating use from 40 °C to +140 °C Possibility of sterilisation by steam up to 130 °C	Permanent operating use from 20 °C to +200 °C Possibility of sterilisation by steam short-term up to 130 °C to 140 °C	Permanent operating use from 25 °C to +110 °C Possibility of sterilisation by steam short-term up to 130 °C	Up to +200 °C it is physiologically harmless, use from 200 °C to +260 °C
Recommended use	High temperature load capacity It has good resistance to cold, suitable for food, it has dielectric properties. It has good resistance to alcohols.	It has good resistance to swelling for: • Diluted inorganic and organic acids, media, oxidising media, lyes, and ketones • Hot water and steam up to 130 °C	It has good resistance to swelling for: • Mineral oils • Plant and animal oils • Lubricants (also some additives) • Fuels	It has good resistance to swelling for: • Aliphatic hydrocarbons (such as propane, butane, benzene, mineral oil) • Lubricants based on mineral oil	It has good resistance to swelling in almost all parts It has a smooth and repellent surface so sticking does not occur It has better chemical resistance than in all other elastomers Non-flammable material
Limited use (border)	Shows high swelling for: • Low-molecular esters and ethers • Aliphatic and aromatic hydrocarbons • Concentrated acids and alkali	Cannot be used for: • Plant and animal oils • Aliphatic, aromatic, and chlorinated hydrocarbons • Mineral oils	Shows high swelling for: • Polar solvents, such as acetone, methyl ketone, ethyl acetate, diethyl ether, and dioxane • Low-molecular organic acids (formic acid and acetic acid) • Gaseous ammonia, amines and alkanes • Overheated water steam	Not resistant to: • Polar solvents • Chlorinated hydrocarbons • Ketones • Aromatic hydrocarbons (benzol) • Esters	Not resistant to: • Liquid alkaline metals and some compounds of fluorine in connection with higher pressure and temperature The material does not show the flexibility of rubber.
Material approval	BGA/FDA	BGA/FDA	BGA/FDA	BGA/FDA	BGA/FDA
BGA = approval of the "Federal Health Authority" in Germany ("Bundesgesundheitsamt") FDA = approval of the "US Food and Drug Administration"					

Technische Informationen für Dichtringe					
Name	Silikon (VMQ)	EPDM (Ethylen-Propylen-Dien- Kautschuk)	Viton (FPM)	Perbunan (NBR)	PTFE (Polytetrafluoräthylen)
Einsatztemperatur	in Wasser bis 100°C beständig Dampfsterilisierbar kurzfristig bis 120°C - 130°C	Dauereinsatz von minus 40°C bis 140°C Dampfsterilisierbar bis 130°C	Dauereinsatz von minus 20°C bis 200°C Dampfsterilisierbar kurzfristig bis 130°C - 140°C	Dauereinsatz von minus 25°C bis 110°C Dampfsterilisierbar kurzfristig bis 130°C	bis 200°C physiologisch unbedenklich, Einsatz von -200°C bis +260°C
typ. Einsatzbereich	hohe thermische Belastbarkeit gute Kältebeständigkeit, für lebensmittel gut geeignet, dielektrische Eigenshaften gute Beständigkeit gegenüber Alkoholen	gute Quellbeständigkeit bei: • verdünnte anorg.- und organische Säuren, Medien, oxidierend wirkende Medien, Laugen und Kentonen • in Heißwasser und Dampf bis 130°C	gute Quellbeständigkeit bei: • Mineralölen • pflanzlichen und tierischen Ölen • Fetten (auch bestimmte Additive) • Kraftstoffe	gute Quellbeständigkeit • aliphatischen Kohlenwasserstoffen (wie Propan, Butan, Benzin, Mineralölen) • Fett auf Mineralölbasis	gute Quellbeständigkeit in nahezu allen Teilen Oberfläche glatt und abweisend, dadurch kein Haften von Rückständen chemische Beständig- keit besser als bei allen anderen Elastomeren kaum brennbar
Einsatzgrenzen	hohe Quellung bei: • niedermolekularen Estern und Ethern • aliphatischen und aromatischen Kohlen- wasserstoffen • konz. Säuren und Alkalien	nicht einzusetzen bei: • pflanzlichen und tierischen Ölen • aliphatischen aromatischen und chlorierten kohlen- wasserstoffen • Mineralöle	stark quellend bei: • polaren Lösungsmitteln wie Aceton, Methyl- keton, Ethylacetat, Diethylether u. Dioxane • niedermolekularen organ. Säuren (Ameisen - und Essigsäuren) • Ammoniakgase, Amine u. Alkanien • überhitzter Wasserdampf	nicht beständig bei: • polaren Lösungsmitteln • chlorierten Kohlen- wasserstoffen • Ketone • Aromaten (Benzol) • Ester	nicht beständig bei: • flüssigen Alkalimetallen und einigen Flourverbindungen in Verbindung mit hohem Druck und Temperatur kein gummielastischer Werkstoff
Werkstoffzulassung	BGA/FDA	BGA/FDA	BGA/FDA	BGA/FDA	BGA/FDA
BGA = Bundesgesundheitsamt FDA = US Food and Drug Administration					



PRODUCER OF STAINLESS PIPING SYSTEMS
HERSTELLER VON EDELSTAHLARMATUREN

NIOB FLUID s. r. o.

Ostrožská 1003
687 25 Hluk
Czech Republic

Phone: +420 572 419 822 - 8
Fax: +420 572 419 868
E-mail: marketing@niobfluid.cz

www.niobfluid.cz